

Article number: 2310431113S

Description: E+G Levelling elements  
LX.25-SW13-SST-M8X24-S

## Measures

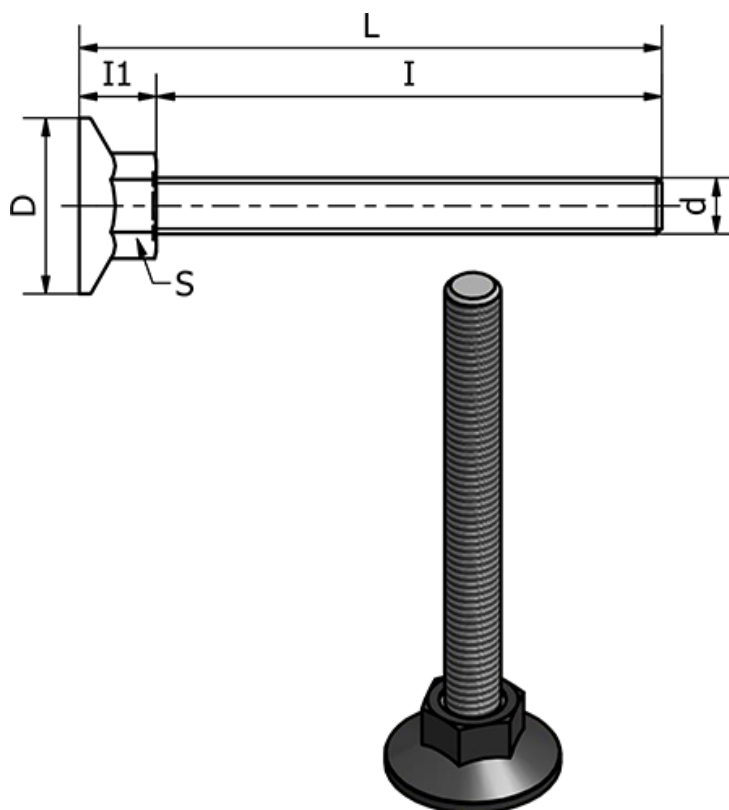

d = M8

D = 25

I = 24

I1 = 11

L = 37

S = 13

Static load in (N) = 1500

Type = AISI 304 Rustfast

Weight (g) = -